

PENNDOT DISTRICT 8-0

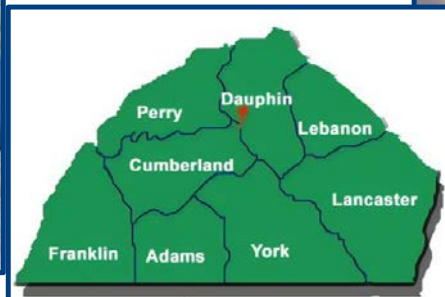
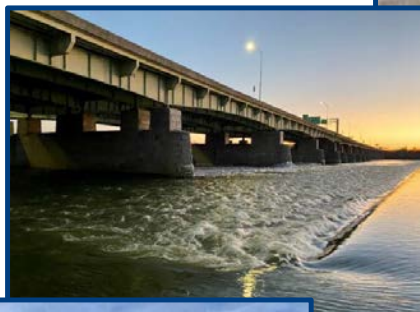

Kevin M. Keefe, PE Acting Transportation District Executive

Richard A Reisinger, PE
Asst. District Executive
(Design)

Mike Reeder, PE
Acting Asst. District Executive
(Construction)

Dale A. Good
Asst. District Executive
(Maintenance)



*"The strength of the team is each individual member.
The strength of each member is the team."*



CHANGING TIMES

New Administration

- Acting Secretary – Michael Carroll
- Executive Deputy Secretary – Cheryl Moon-Sirianni
- Acting Deputy Secretary for Highway Admin – Michael Rebert
 - Acting District Executive for D-5 – Chris Kufro
 - Acting District Executive for D-8
 - Kevin Keefe (April – June)
 - Rich Reisinger (July – September)



CHANGING TIMES

District Office

- Acting ADE-Construction – Mike Reeder
- Principal ACE's
 - Mike Deiter – Cumberland/Dauphin/Perry
 - Barb Karsok-Anderson – Lancaster/Lebanon
 - Mike Reeder – Adams/Franklin/York
- District Traffic Engineer – Chris Flad
- District Permits Manager (HOP) – Eric Kinard



ACCOMPLISHMENTS

Ephrata DDI



I-83 Widening



Routes 94/394 Roundabout



York DDI



Life, Liberty and the Pursuit of Happiness

Safe Harbor



ACCOMPLISHMENTS

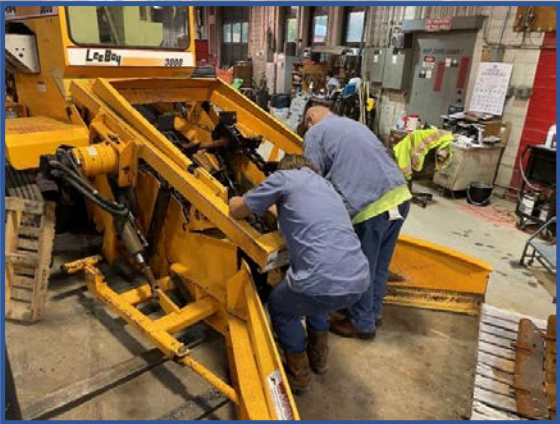

2023 SIGNIFICANT PROJECTS

Columbia/ Wrightsville Bridge

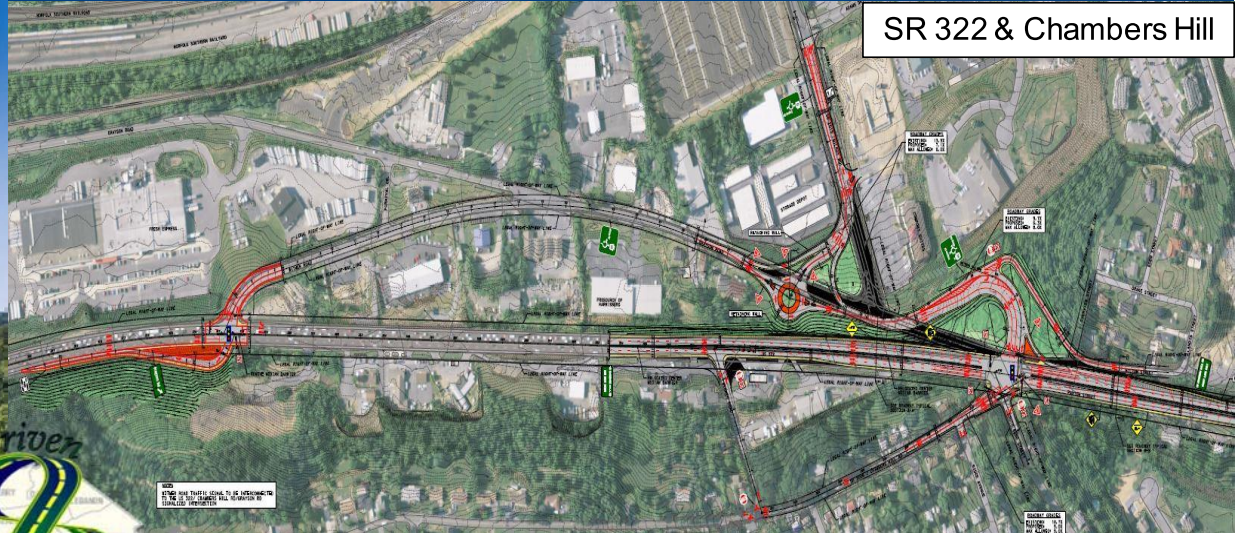

SR 322 & Chambers Hill



I-83 East Shore Section 3



2024 SIGNIFICANT PROJECTS

Market Street Bridge

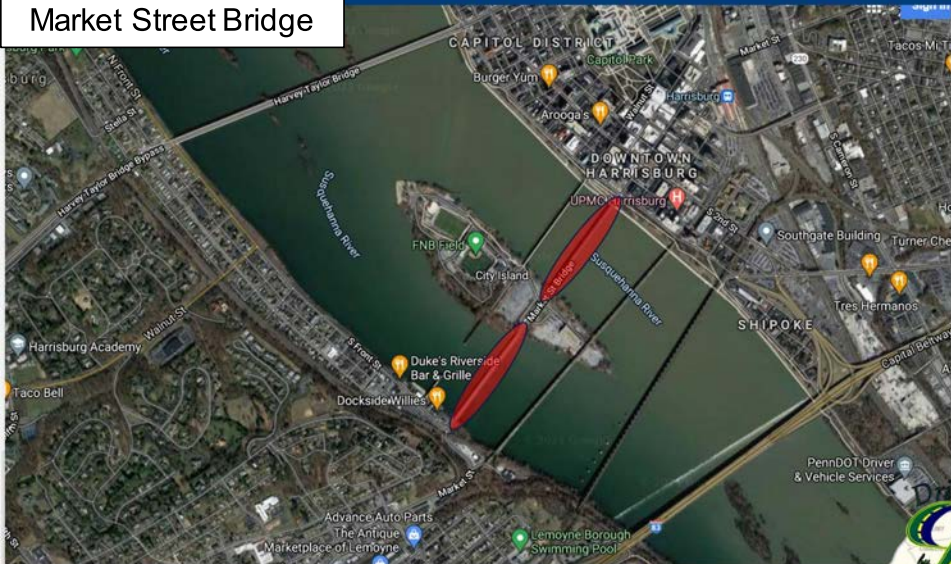

Maclay Street Bridge



Existing 4-Lane Roadway

Proposed Maclay Street Widening

- Roadway and Bridges will be widened from 62' (existing) to 86'-4" (proposed)
- Existing – four 11' wide lanes with 8' wide sidewalks
- Proposed - five 11' wide lanes, two 6' wide bike lanes, and two 8'-8" wide sidewalks

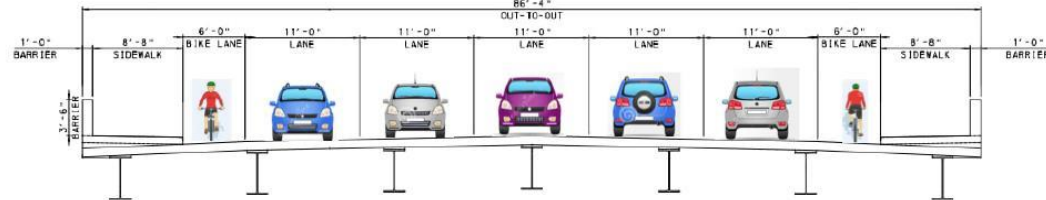

Proposed 5-Lane Roadway with Bike Lanes
(looking east toward Farm Show)

I-83 North York (Codus Section)



FUTURE SIGNIFICANT PROJECTS

US 322 Clarks Ferry/ Riverlands

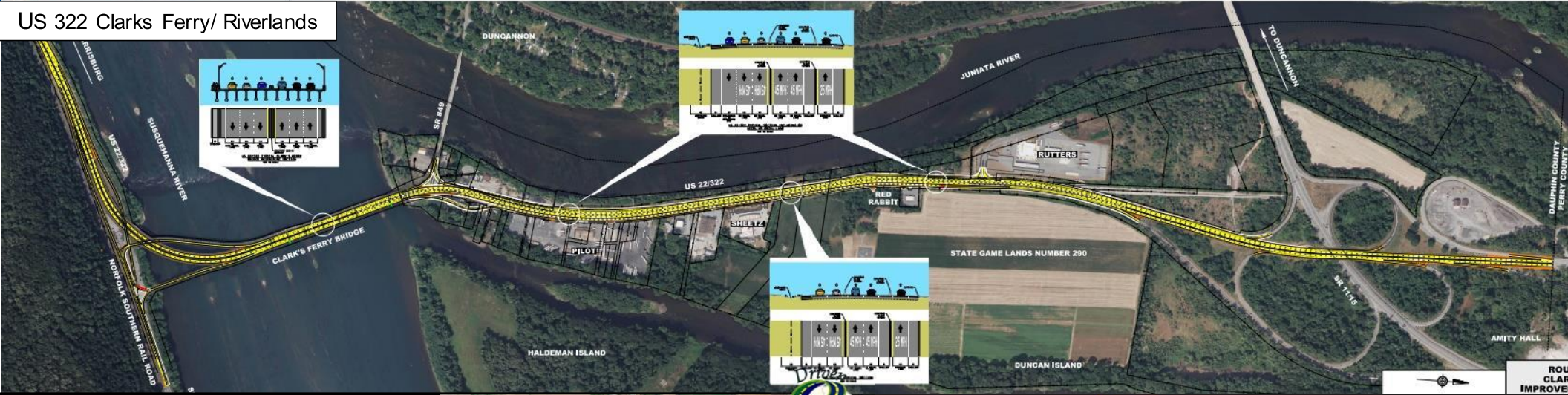

I-83 North York Widening (Exits 21 & 22)



I-83 Eisenhower Interchange

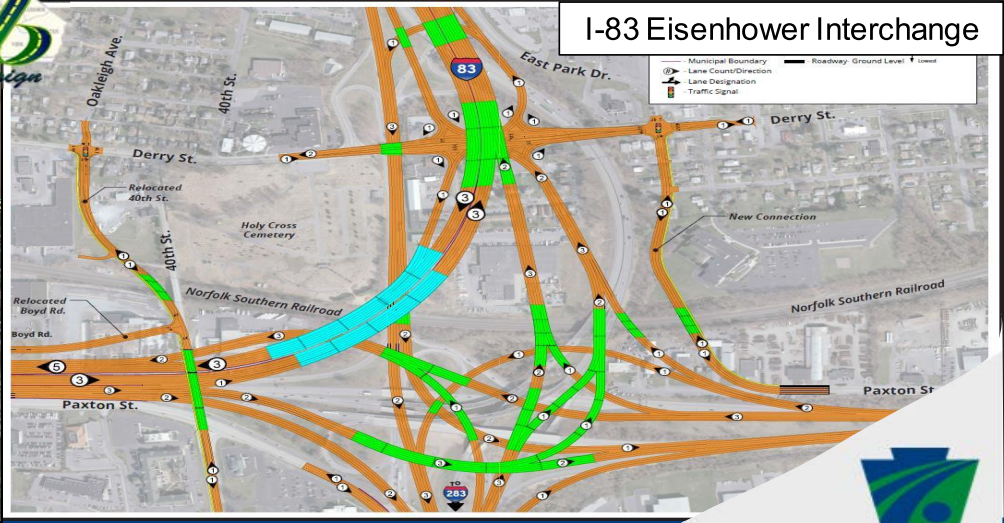

INFRASTRUCTURE INVESTMENT & JOBS ACT (BIL)

Highlights

- Welcome increase at Federal level (\$0.184/gallon since 1993)
- Will address a portion of our unmet funding needs
- Matching state funds (typically 20%)
- Identify state funds to leverage new Federal funds
- Capital Budget needed to ensure future projects can move forward
- Covers FFY '22-'26 Transportation Improvement Program (TIP)



DISTRICT ASSET MANAGEMENT, PROJECT DELIVERY, AND FUTURE PLANS

AVERAGE YEARLY FUNDING LEVEL BY MPO (\$M)

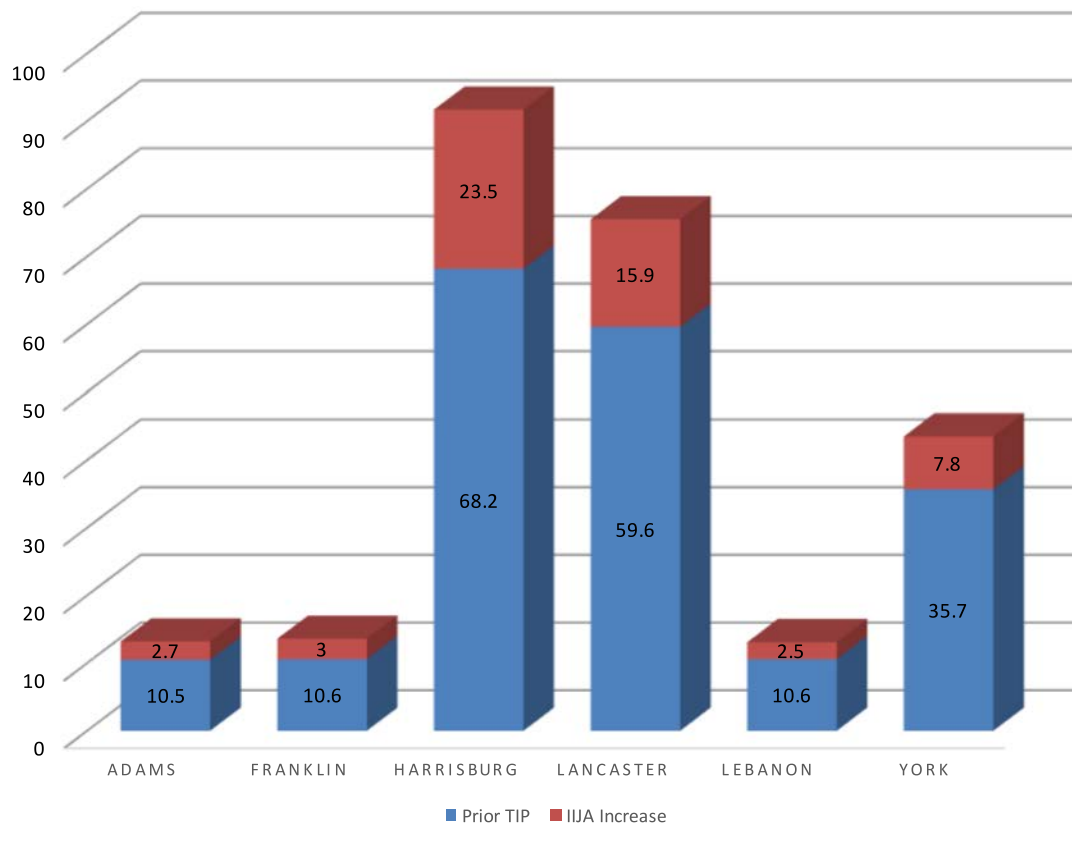

Local Bridges on 2023 TIP

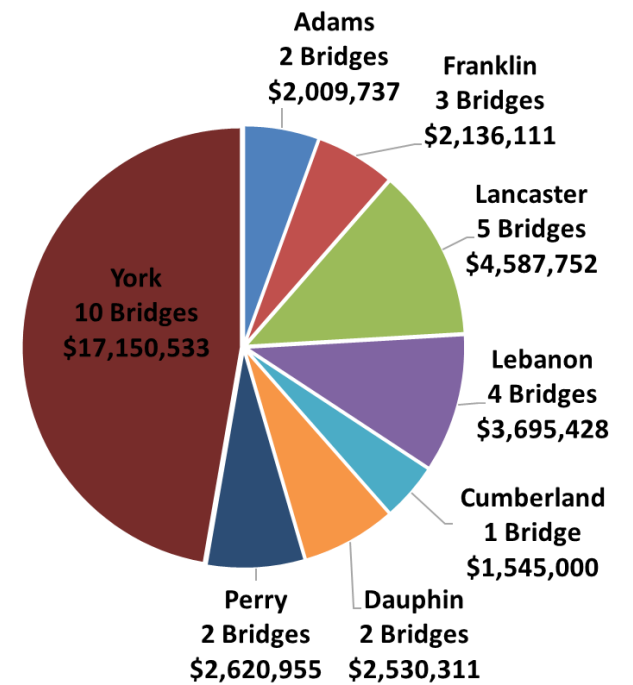

DISTRICT ASSET MANAGEMENT, PROJECT DELIVERY, AND FUTURE PLANS

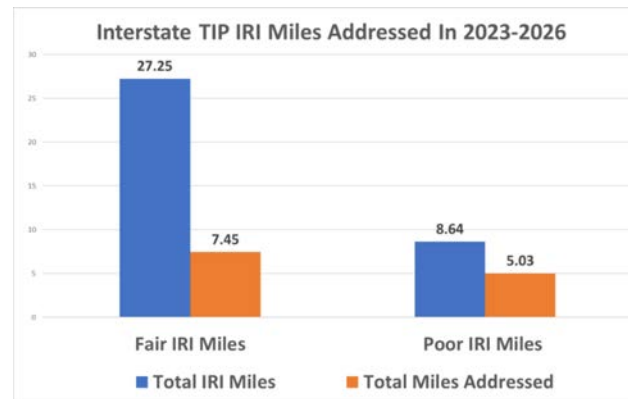
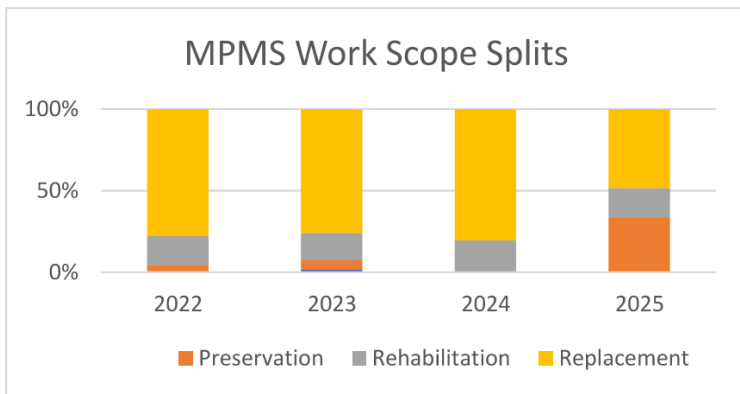
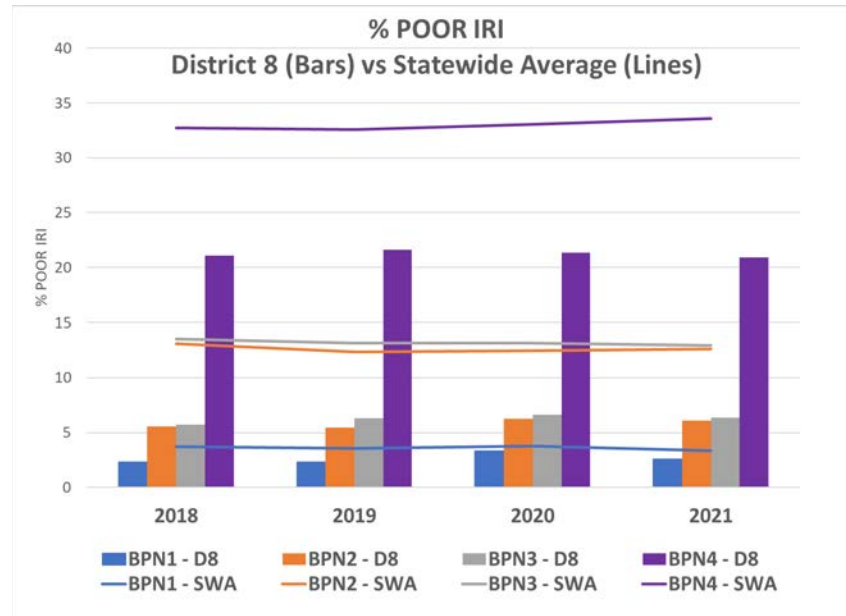
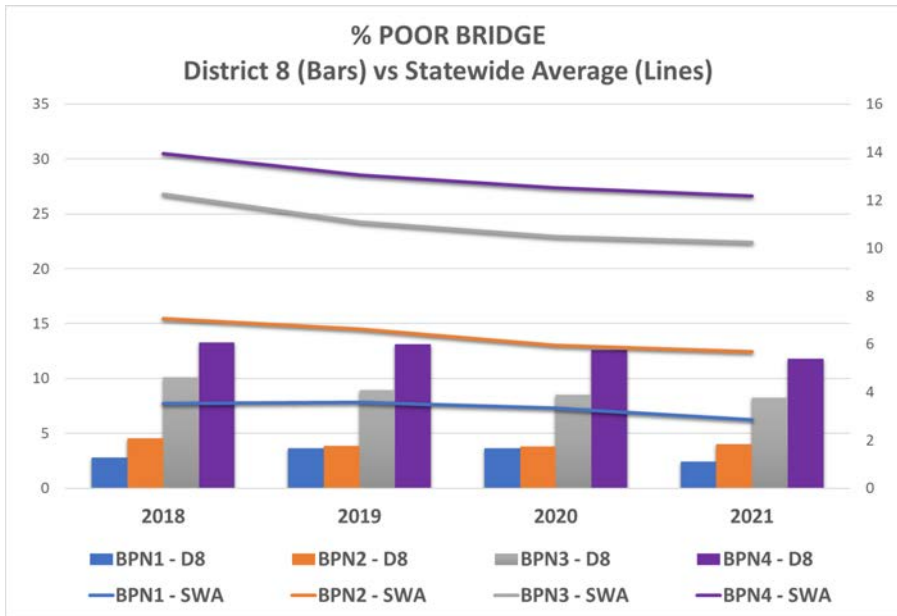

ORGANIZATIONAL SMART PRACTICES, LEAN AND INNOVATIVE IDEAS

- Void Reducing Asphalt Membrane (VRAM)
 - Polymer modified asphalt material installed under asphalt longitudinal joints of asphalt pavement to reduce voids
- Foamed Glass Aggregate (FGA)
 - Lightweight aggregate used to mitigate settlement
- SR 30-Lancaster: Contraflow Gates



Contraflow Gates



Foamed Glass Aggregate



VRAM



Remote Dynamic Pile Analysis



ORGANIZATIONAL SMART PRACTICES, LEAN AND INNOVATIVE IDEAS



ENGINEERING AND CONSTRUCTION MANAGEMENT SYSTEM

- **Leverage ECMS**
 - Batched Planned Projects
 - ROW Demo Contracts Let in ECMS
- **Utilize Technology**
 - Mobile Lidar
 - Paleo digger
- **Use More Consultant Support**
 - Conditional Assessment SCM Inspection
 - Consultant Project Managers / Reviews
- **Support Dept Initiatives**
 - Drainage Digital Delivery Pilot
 - Mentor Protégé Program



Paleo Digger

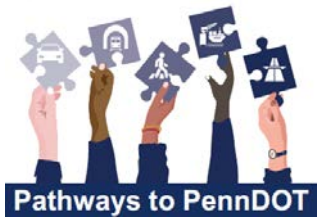
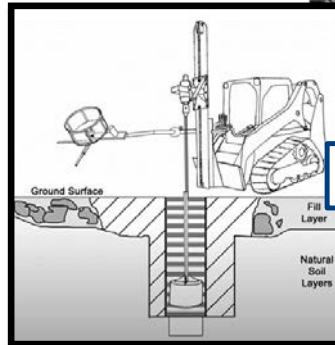

THANK YOU!

