

# PA TURNPIKE – TUNNEL PROGRAM

**Brad Updegrave, P.E.**  
**Assistant Bridge Engineering Manager**

**John Boyer, E.I.T.**  
**Bridge Engineering Project Manager**





**Allegheny Mountain  
Tunnels**

**Blue Mountain and  
Kittatinny Mountain  
Tunnels**

**Tuscarora Mountain Tunnels**

**Lehigh Tunnels**

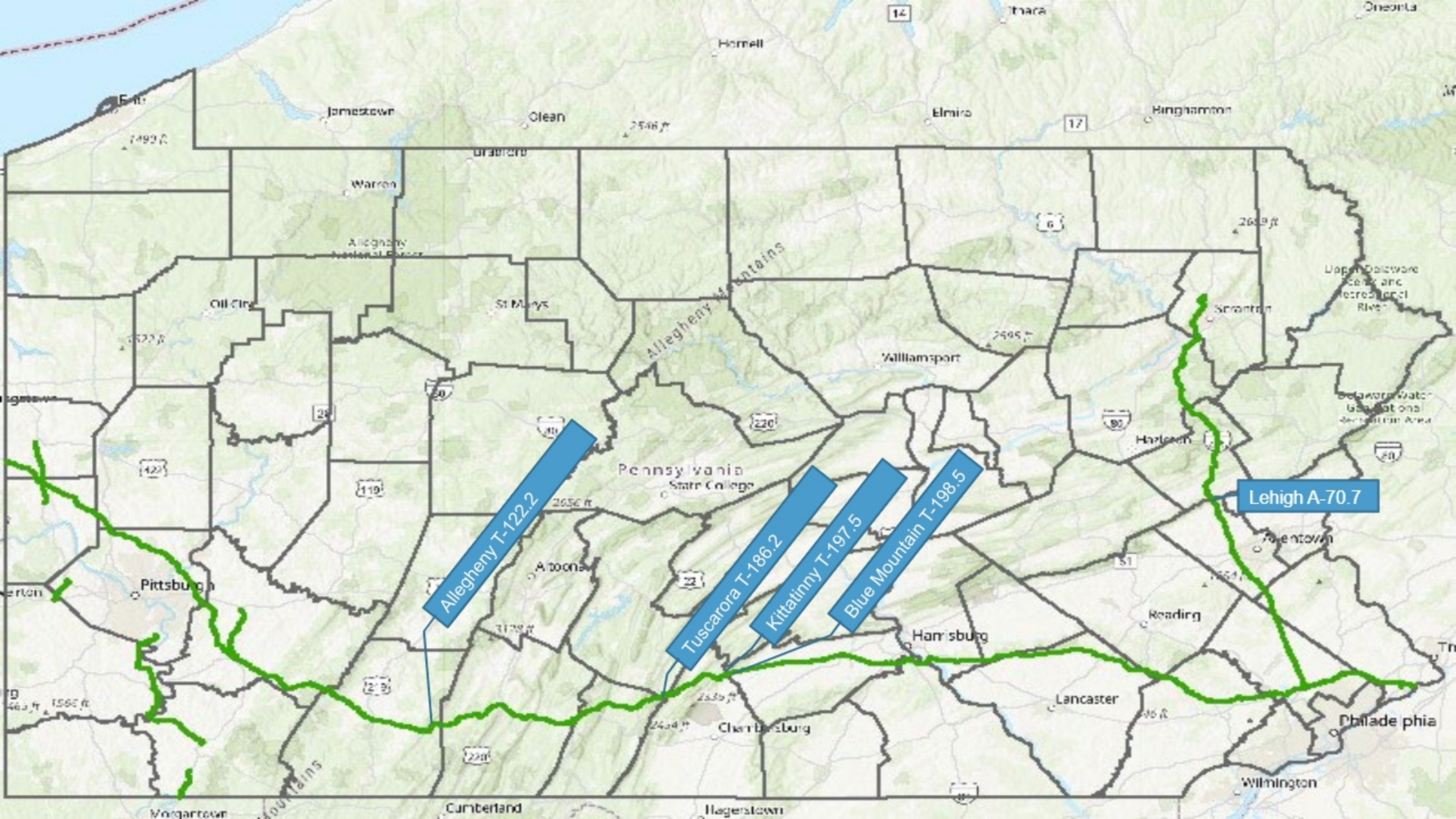

Allegheny T-122.2

Tuscarora T-186.2

Kittatinny T-197.5

Blue Mountain T-198.5

Lehigh A-70.7

# TYPICAL TUNNEL SECTIONS

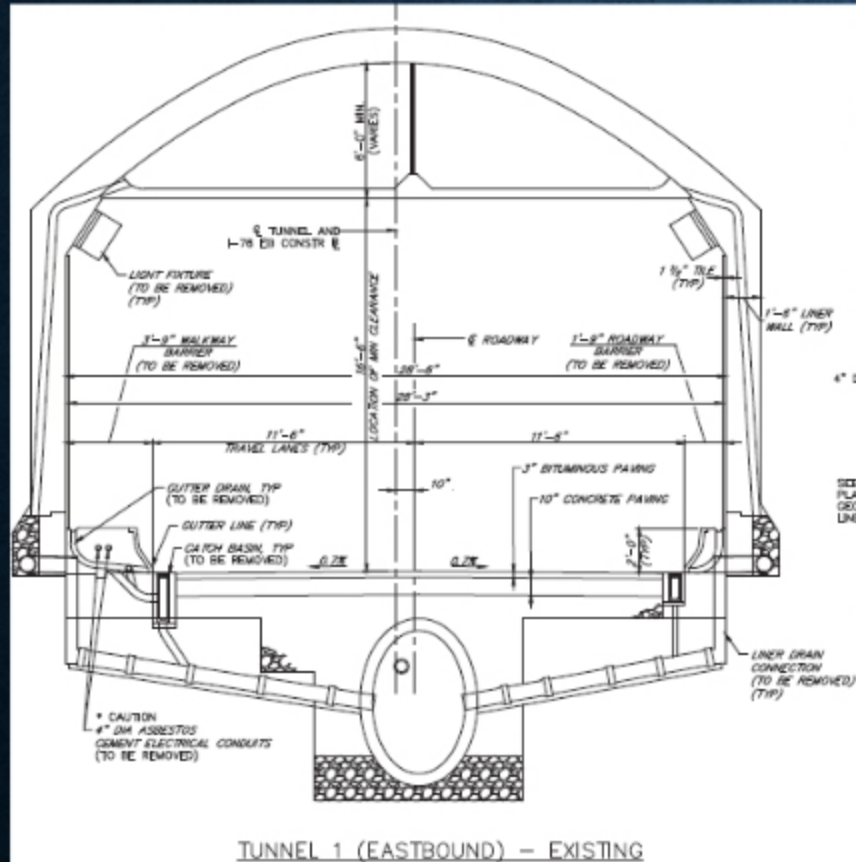

TUNNEL 1 (EASTBOUND) - EXISTING

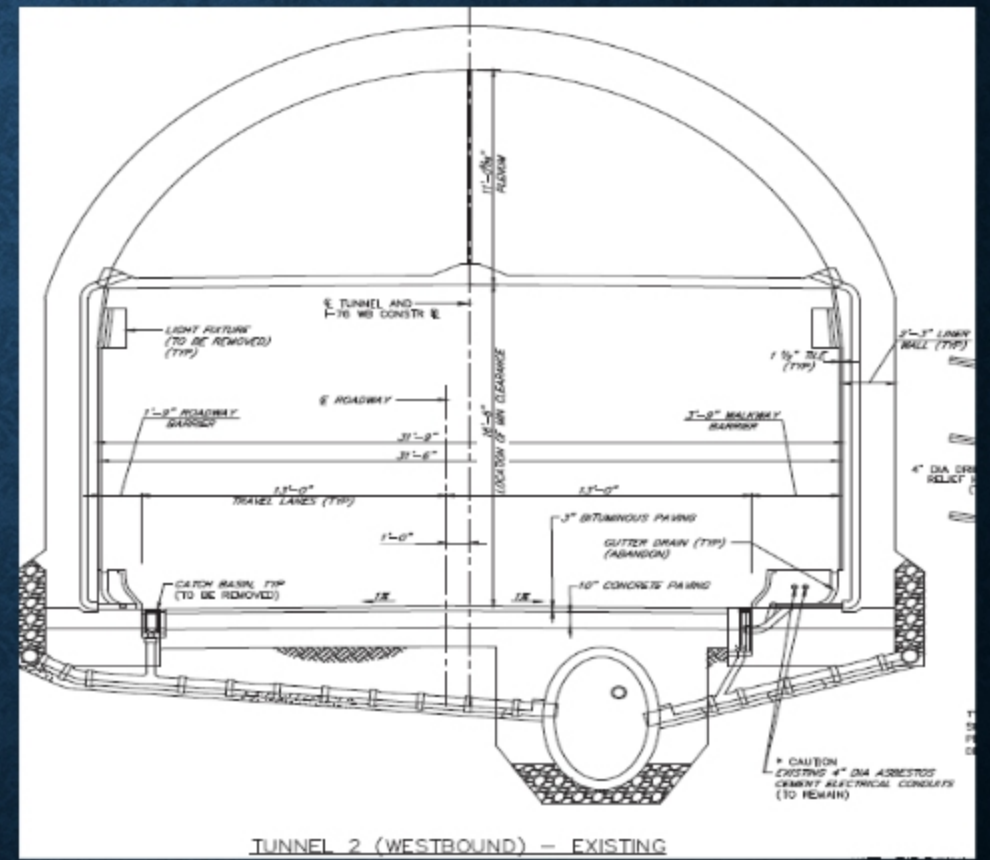

TUNNEL 2 (WESTBOUND) - EXISTING

# TYPICAL VENTILATION SYSTEM

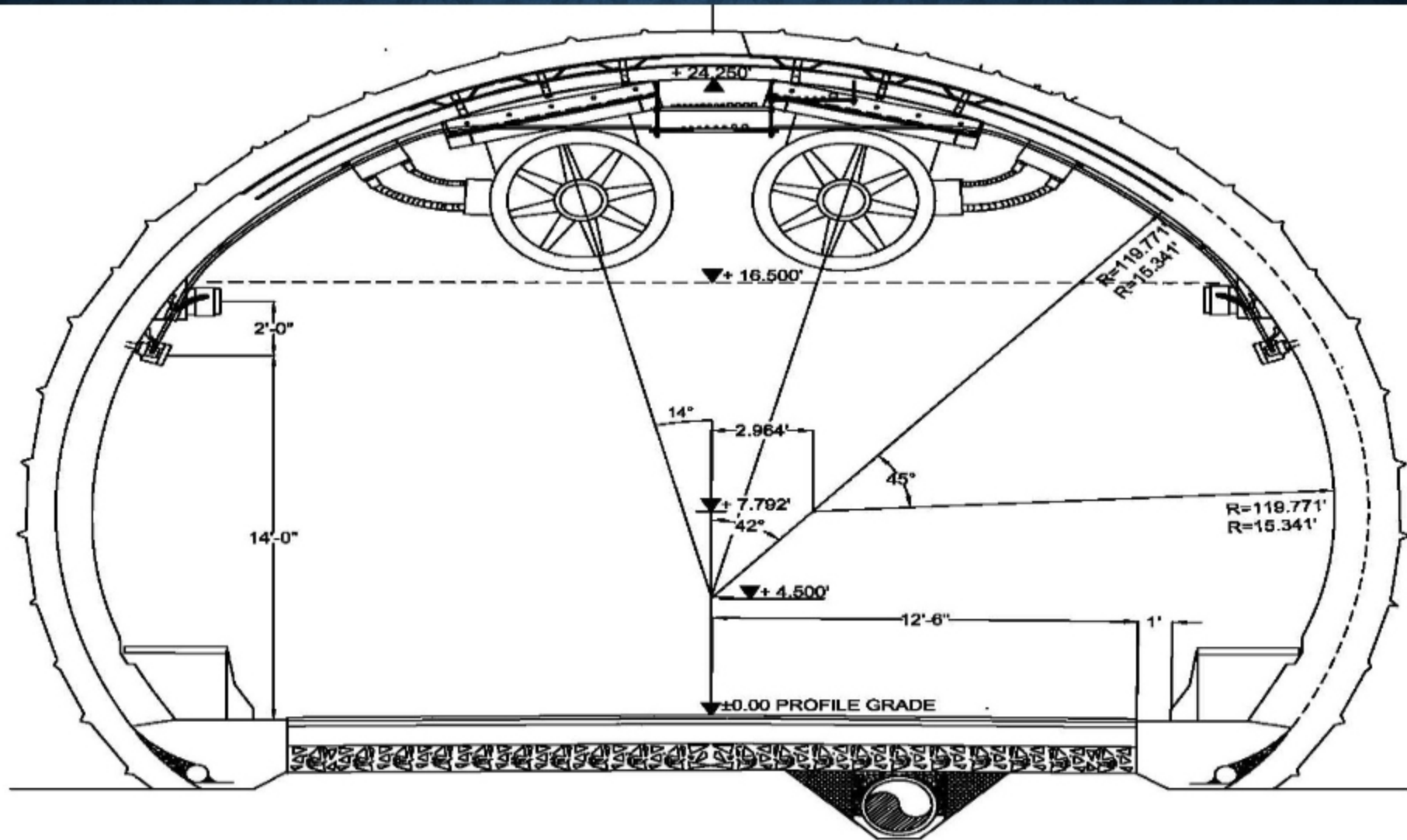

# WHAT IS THE TUNNEL PROGRAM??

- **INSPECTION**
- **MAINTENANCE**
- **REPAIRS/REHABILITATION**

# TUNNEL INSPECTION

- **FHWA MANDATE**
- **NCTI CERTIFICATION**
- **SPECIFICATIONS FOR NATIONAL TUNNEL INVENTORY (SNTI)**
- **TUNNEL OPERATIONS, MAINTENANCE, INSPECTION AND EVALUATION MANUAL (TOMIE)**
- **ELEMENT LEVEL INSPECTIONS**





## ***INSPECTION ITEMS***

- ***STRUCTURAL***
- ***MECHANICAL***
- ***CIVIL***
- ***ELECTRICAL***
- ***FIRE SAFETY***





# STRUCTURAL

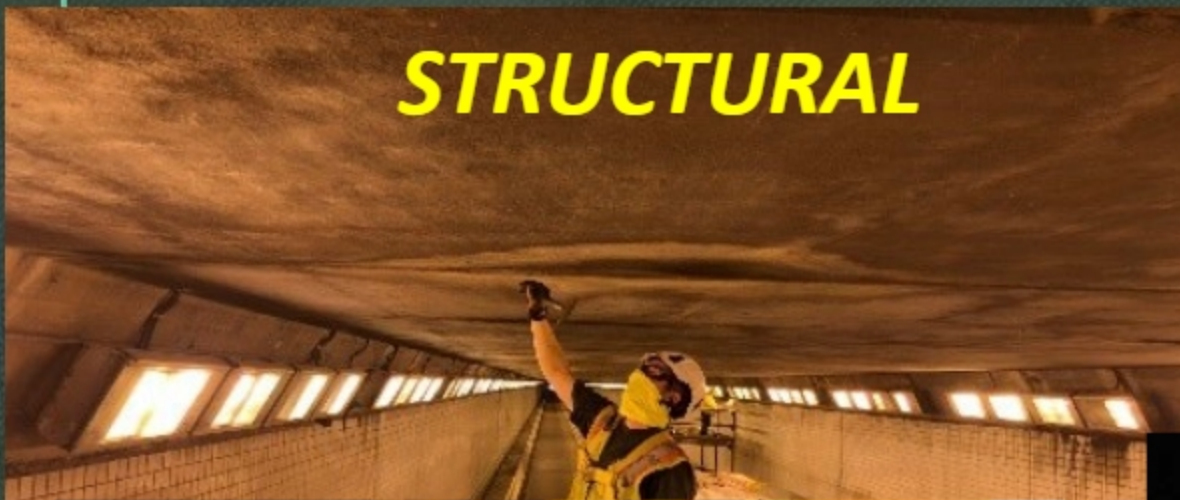

# ***“RETAIN THE KNOWLEDGE”***

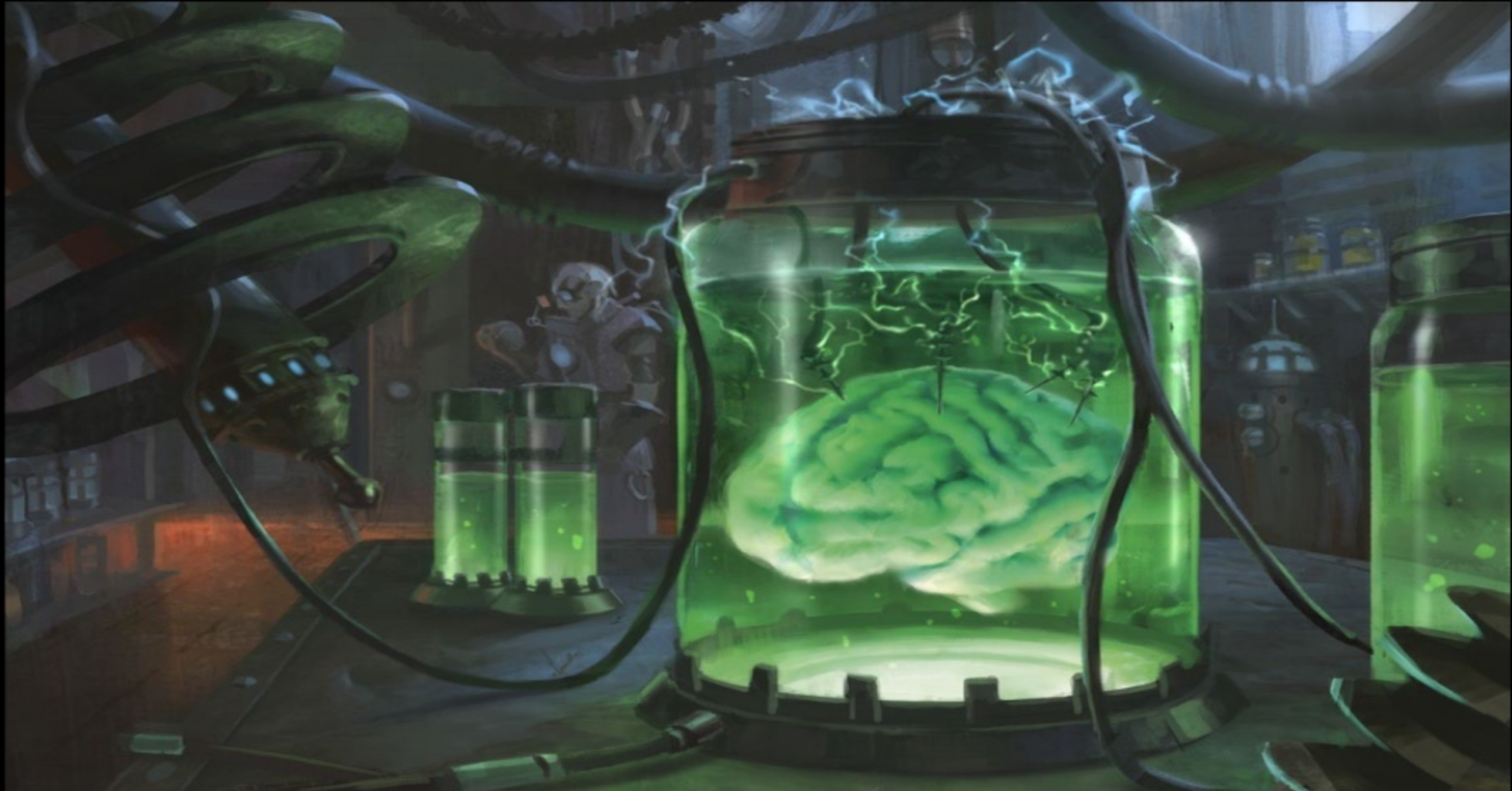

# ELECTRICAL



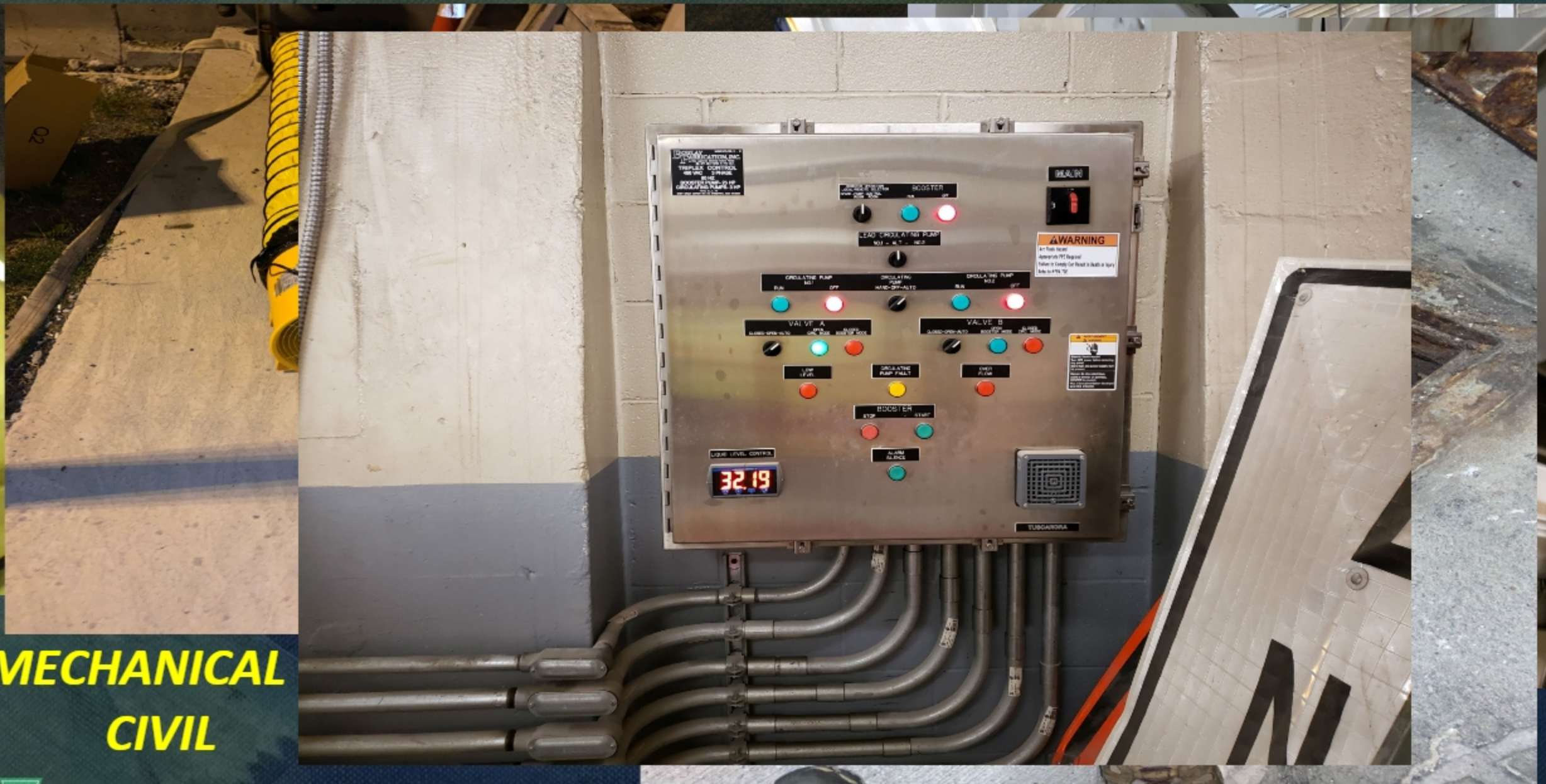

**MECHANICAL  
CIVIL**



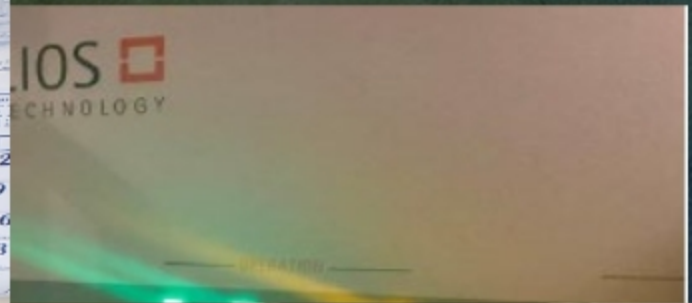

**FIRE & LIFE  
SAFETY**



## WHAT DO WE DO WITH THE DATA?

- **MAINTENANCE**
- **REPAIRS VIA CONTRACTOR**
- **REHABILITATION**





## MAINTENANCE

- **CLEANING**
- **REPAIRS**
- **ICE REMOVAL**
- **INSPECTION ASSISTANCE**
- **EMERGENCY RESPONSE**

# LIGHTING REPLACEMENT







## REHABILITATIONS

- TUSCARORA
- BLUE – KITT
- LEHIGH

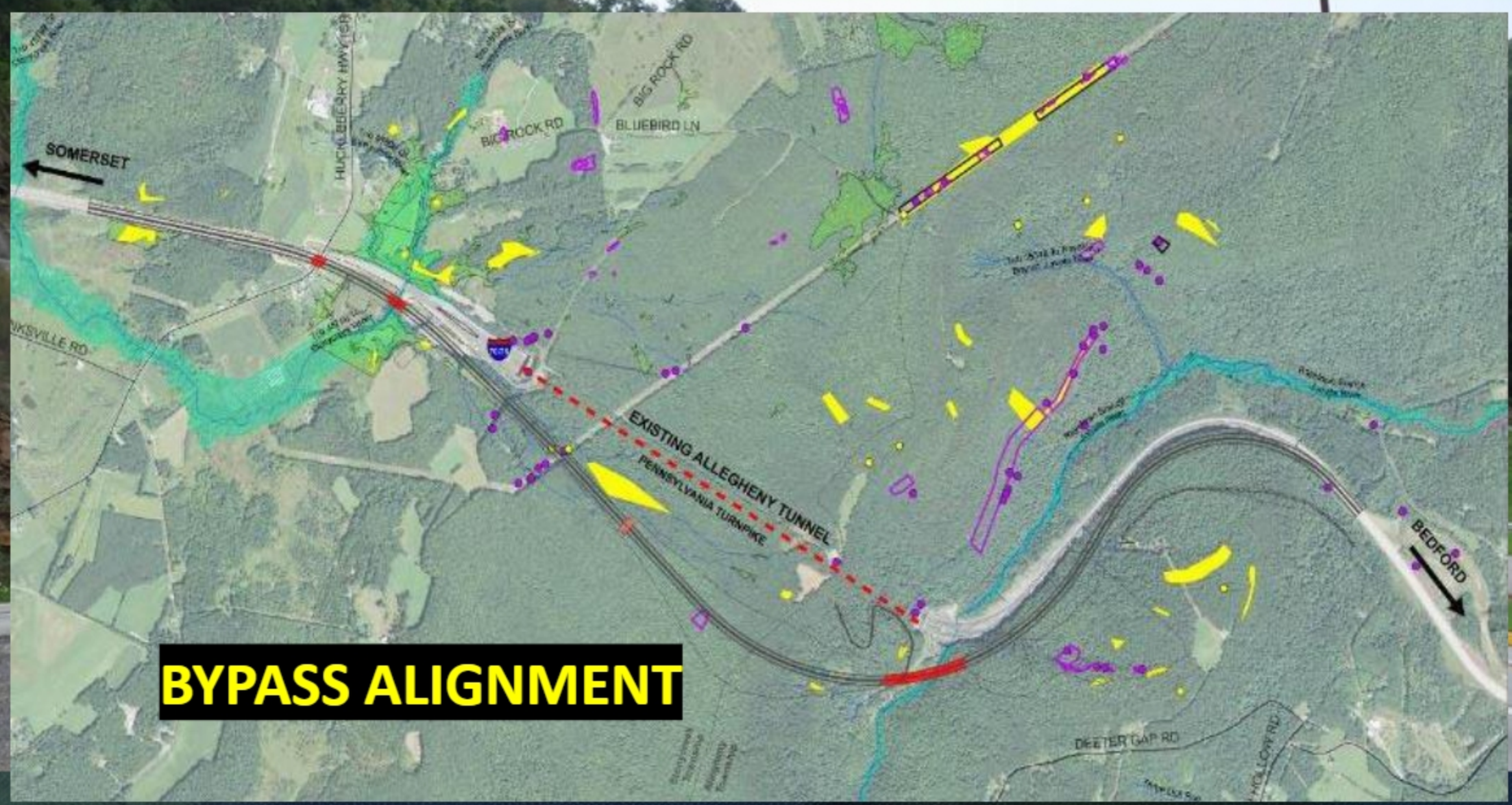

**BYPASS ALIGNMENT**

# Tuscarora Tunnel Rehabilitation



# CONSTRUCTION UPDATE

- BID DATE: June 19, 2019
- Notice to Proceed: July 31, 2019
- Contract Completion Date: June 23, 2023
- Contract Amount \$109,977,777.00
- Contractor: Mosites Construction Company
- CM/CI: JMT Engineering
- Designer: Gannett Fleming



# QUICK DESIGN PROCESS RECAP

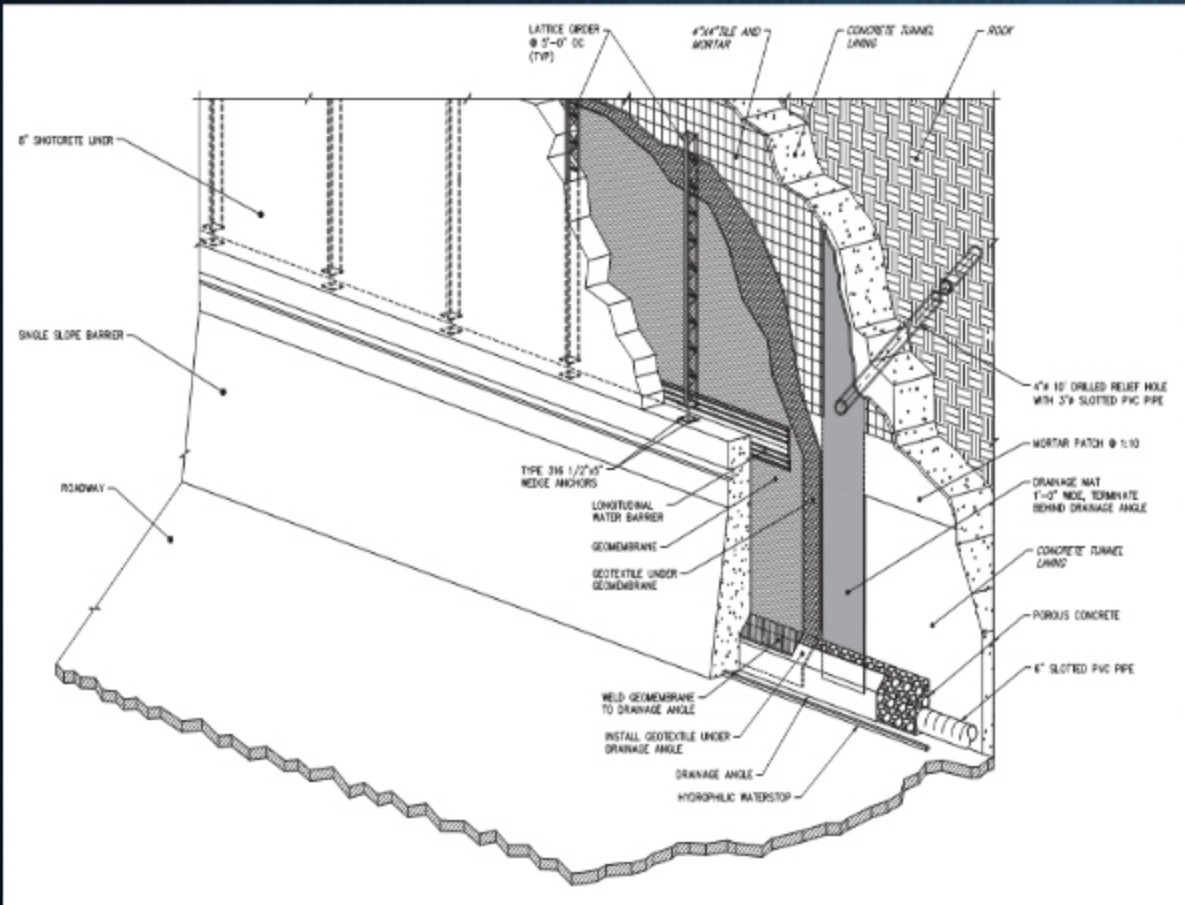

## • Elements of Rehab

- Remove Ceiling In Tunnel 1
- Reduce Black Hole Effect at Portals
- Control Water Infiltration
- Drainage Improvements
- NFPA 502 Life Safety Upgrades
- Energy Efficient LED Lighting in Stainless Fixtures.
- Repairs to Preserve Tunnel Asset.

# MAJOR WORK COMPLETED

- Early Action Items
- Ceiling Removal
- New Barrier and Drainage Inlets

# EARLY ACTION ITEMS

## LANE CONTROL SIGNS



## BIDIRECTIONAL LIGHTING

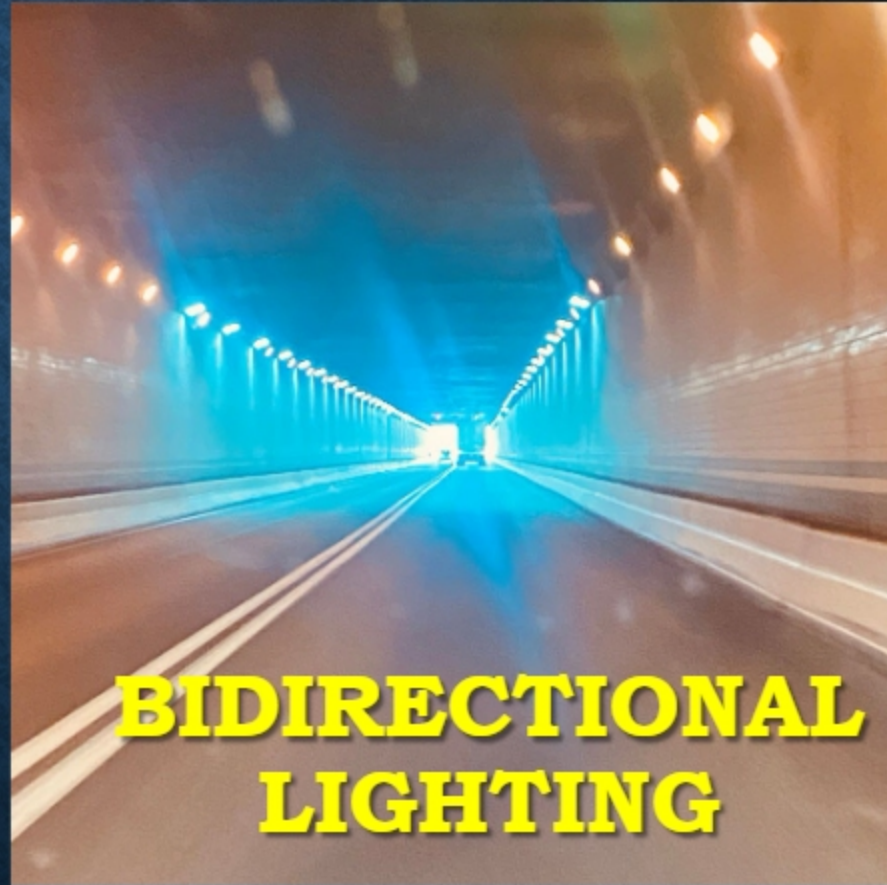

# CEILING REMOVAL TUNNEL





# NEW BARRIER AND DRAINAGE INLETS



# CURRENT WORK

- Waterproofing
- Shotcrete
- Shotcrete Debris
- Lights
- Fans
- Electrical Work

# WATERPROOFING



# SHOTCRETE



# SHOTCRETE DEBRIS

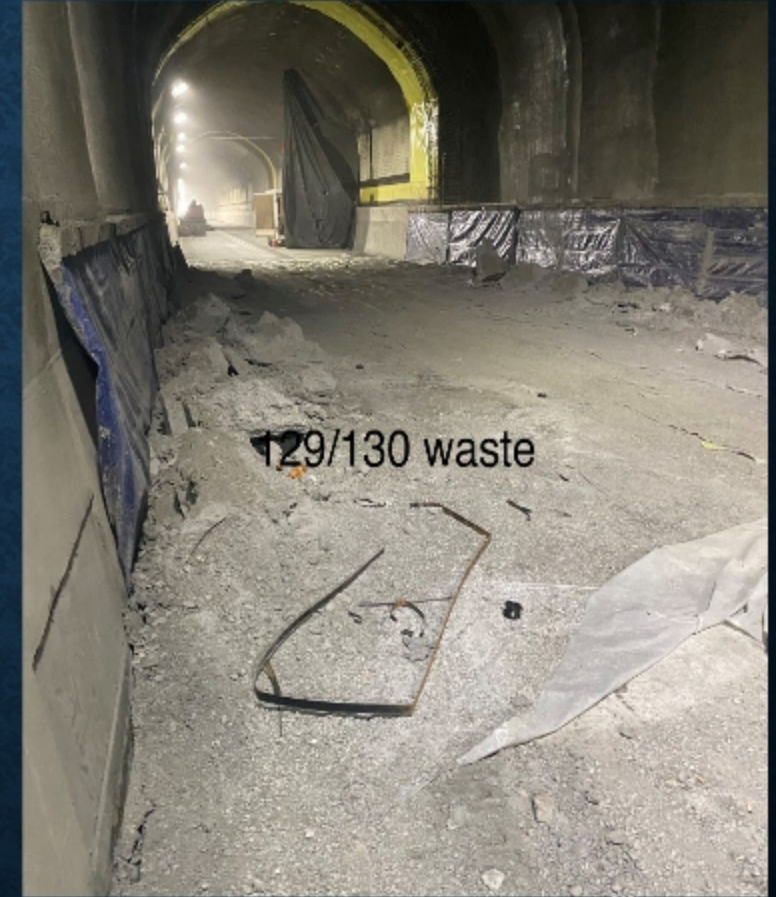

# LIGHTING



# FANS



# SCHEDULE

- Waterproofing to be completed by Early May.
- Shotcreting to be completed by Memorial Day Holiday
- Epoxy Coatings starting mid-April and anticipated to be completed this summer.
- Paving in Tunnel and approaches in the month of June
- Switch to Tunnel 2 is anticipated to be late Summer/Early Fall.



# BLUE MOUNTAIN AND KITTATINNY TUNNEL REHABILITATION



# BLUE MOUNTAIN AND KITTATINNY TUNNEL REHABILITATION

- Designer:

STAHL SHEAFFER  
ENGINEERING

- Early Action Contract
  - Swift Gates, Lane Control Signs, DMS Signs, etc.
  - Bid July 2022
- Rehabilitation Contract
  - Targeting mid 2024 Let Date.



# QUESTIONS?

